

DESIGN
COLLECTION
2020



**Mulholland
Brand**

www.mulhollandbrand.com

Gates, Fences & More



PRODUCTS DESIGN
Collection

Copyright ©
MULHOLLAND BRAND,
mulhollandbrand.com
818.806.0711



03	Welcome to Mulholland
10	White Glass Gates & Fences
12	Black Glass Gates & Fences
14	24 Series Gates & Fences
16	Mixed 24 Series Gates & Fences
18	Mixed Glass 24 Series Gates & Fences
20	Solid Gates & Fences
24	Wood-Like Gates & Fences
26	Framed Hi-Tech Gates & Fences
28	Floating Hi-Tech Gates & Fences
30	45° Series Gates & Fences
32	Tandem Gates
34	Aluminum Railings
36	Aluminum Pergolas
40	Crystal Line Railings
41	Fusion Line Railings
42	Open Air Railings

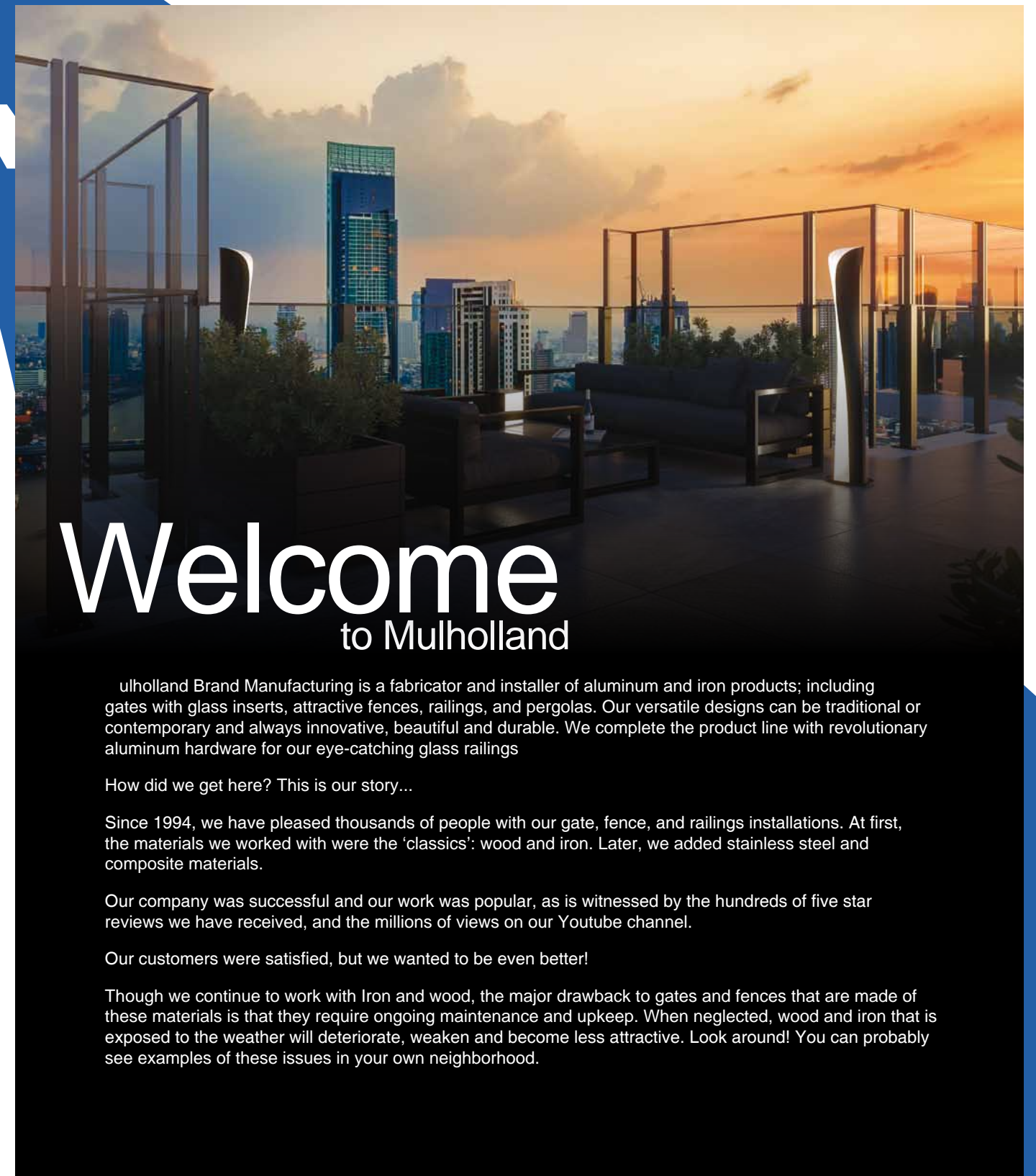

Welcome to Mulholland

Mulholland Brand Manufacturing is a fabricator and installer of aluminum and iron products; including gates with glass inserts, attractive fences, railings, and pergolas. Our versatile designs can be traditional or contemporary and always innovative, beautiful and durable. We complete the product line with revolutionary aluminum hardware for our eye-catching glass railings

How did we get here? This is our story...

Since 1994, we have pleased thousands of people with our gate, fence, and railings installations. At first, the materials we worked with were the 'classics': wood and iron. Later, we added stainless steel and composite materials.

Our company was successful and our work was popular, as is witnessed by the hundreds of five star reviews we have received, and the millions of views on our Youtube channel.

Our customers were satisfied, but we wanted to be even better!

Though we continue to work with Iron and wood, the major drawback to gates and fences that are made of these materials is that they require ongoing maintenance and upkeep. When neglected, wood and iron that is exposed to the weather will deteriorate, weaken and become less attractive. Look around! You can probably see examples of these issues in your own neighborhood.

Mulholland Welcomes Aluminum to the Company:

Aluminum alloys that can be used to fabricate quality gates and fencing are available and have been used in Europe for many years, but for the longest time, were not available in the US market. Only low quality and simple gate and fence designs were available. In 2016, we were introduced to the Trellidor Company of Israel and our outlook changed. We were dazzled by their innovative design and were impressed by the quality of their products. We understood that their gates and fences would require very infrequent maintenance. We knew that would be a hit with our clients.

And so, we made arrangements to represent Trellidor in the US, initially as distributors.

We were right! People loved the beauty of the gates and appreciated the quality of the work. Most of all, they relished the durability, maintenance free convenience.

Together with Trellidor, we set up the manufacturing facility in Canoga Park, California, where we have the production capability that allows us to work in the Los Angeles area, as well as with dealers, contractors, and installers nationwide!

What makes aluminum gates, railings, and fences great?

- Aluminum doesn't rust.
- Aluminum does not deteriorate as wood does.
- High-quality aluminum gates, fencing, and railing will look and perform great for a long time.
- Aluminum gates are lightweight, causing less stress on posts and gate operators, which can last longer.

What makes aluminum gates and fences great for contractors and installers?

- Aluminum's light weight allows installations with smaller crews and less work. End the day with pride instead of exhaustion!
- Less call backs for maintenance, sagging gates, and paint touch ups.

But of course, it has to look good too.

- Profile and glass combinations allow for great modern designs.
- The strength and light weight of aluminum allows us to use very narrow profiles for a contemporary look, while still being strong and durable.
- Use of compact gate operators (unlike using a 'big black box' on the driveway).
- Rack and pinion mechanism for sliding gate (no rusted and oily chain hanging in the back and staining the concrete).

My driveway is sloped. My house is built on a hill, but I still want to install a gate.

- Lightweight aluminum gate means that the gate operator will not need to work as hard to pull the gate up the slope.
- Gates and fence panels made of aluminum can be engineered to "follow the slope" or for a "level top" look.

Gates, fences, railings and pergolas are finished with high quality powder coating. Large color selection provides for additional customization possibilities. Glass panels and inserts that are incorporated into the gate designs are laminated for additional security and can be made white, black, or clear.

"Wood-like" finish of aluminum profiles is another popular option and is available in several patterns. The aluminum profiles go through a sublimation process that is just as durable as powder coat paint to create a textured and varied look.

The customization of the gates, railings and fences is also achieved through 'mix and match' of the various profiles to create new designs and updated looks.

All standard accessories (such as safety devices, keypads, intercoms, etc.) can also be installed on aluminum gates. We use high quality mortise locks for our pedestrian gates and can install different styles of handles, as well as discrete hydraulic door closers.

At Mulholland Brand, each item is made to order based on the exact specifications of the customer; size, color, and design. We inspect each piece to make sure that the finish looks clean and polished and the welds are hidden wherever possible.

When you work with Mulholland, you are working with competent, professional, and approachable experts who are masters of their craft. You, our client, is the most important person. We look forward to working with you to make the most beautiful addition to your home!





We are artisans of aluminum.



Our hand made products have that special one-of-a-kind look.



We installed this aluminum enclosure with white glass insert panels in Los Angeles, California. January 2020



We created a security and privacy barrier to compliment this beautiful house in Mar Vista, California. May 2020



This gate was designed with a beautiful basket-weave pattern.

White Glass Gates & Fences

Modern designs. Suitable for a wide variety of home styles. Ready for installation. Maximum glass panel size 3'x4'. Fences and gates are made of aluminum frame with white laminated glass inserts.

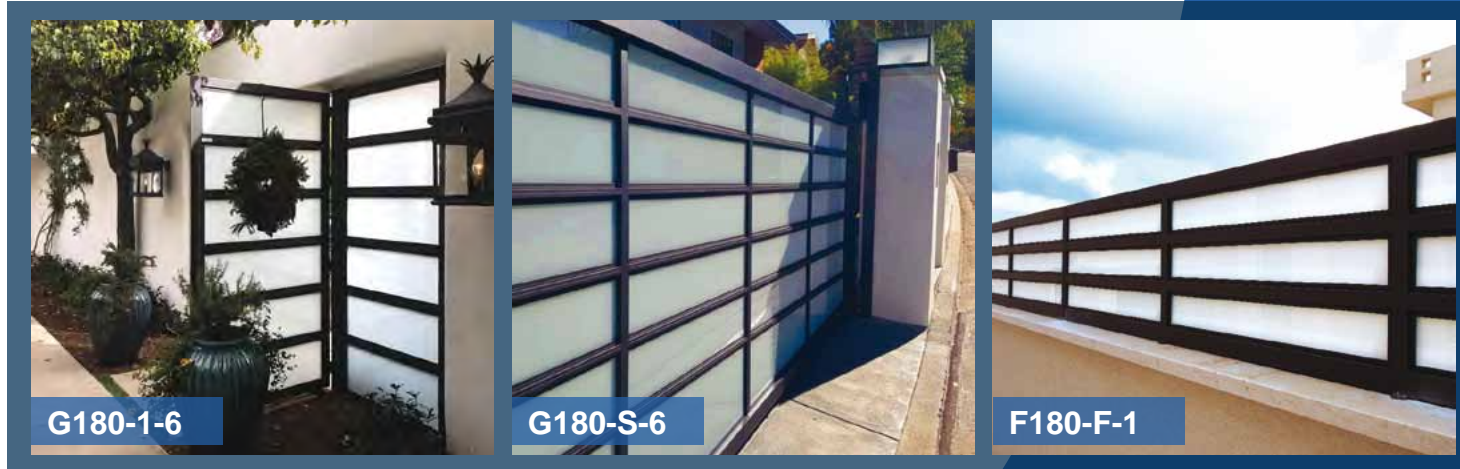

Code indicates the number of rows. Number of columns is based on the width of the gate or fence.

White Glass Gates & Fences

	Single Swing - 2 Rows	G180-1-3
	Double Swing - 2 Rows	G180-2-3
	Sliding - 2 Rows	G180-S-3
	Overhead - 2 Rows	G180-O-3
	Fence - 2 Rows	F180-F-3
	Single Swing - 3 Rows	G180-1-1
	Double Swing - 3 Rows	G180-2-1
	Sliding - 3 Rows	G180-S-1
	Overhead - 3 Rows	G180-O-1
	Fence - 3 Rows	F180-F-1
	Single Swing - 4 Rows	G180-1-2
	Double Swing - 4 Rows	G180-2-2
	Sliding - 4 Rows	G180-S-2
	Overhead - 4 Rows	G180-O-2
	Fence - 4 Rows	F180-F-2
	Single Swing - 5 Rows	G180-1-5
	Double Swing - 5 Rows	G180-2-5
	Sliding - 5 Rows	G180-S-5
	Overhead - 5 Rows	G180-O-5
	Fence - 5 Rows	F180-F-5
	Single Swing - 4 Rows	G180-1-4
	Double Swing - 4 Rows	G180-2-4
	Sliding - 4 Rows	G180-S-4
	Overhead - 4 Rows	G180-O-4
	Fence - 4 Rows	F180-F-4
	Single Swing - 6 Rows	G180-1-6
	Double Swing - 6 Rows	G180-2-6
	Sliding - 6 Rows	G180-S-6
	Overhead - 6 Rows	G180-O-6
	Fence - 6 Rows	F180-F-6

Black Glass Gates & Fences

Modern designs. Suitable for a wide variety of home styles. Ready for installation. Maximum glass panel size 3'x4'. Fences and gates are made of aluminum frame with black laminated glass inserts.



G180B-S-2



G180B-1-1



G180B-S-1



G180B-S-2



G180B-1-2



G180B-1-2



G180B-S-2



G180B-S-1

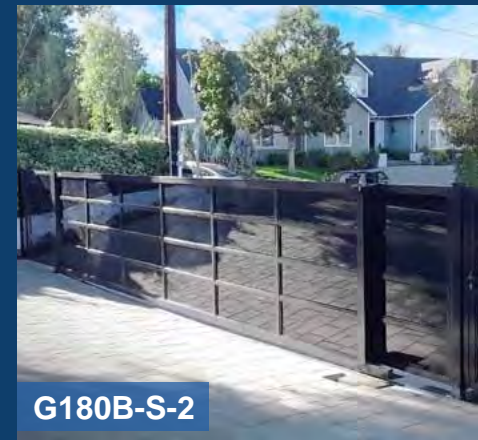

G180B-S-2

Code indicates the number of rows. Number of columns is based on the width of the gate or fence.

Black Glass Gates & Fences

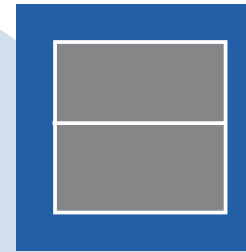

Single Swing - 2 Rows	G180B-1-3
Double Swing - 2 Rows	G180B-2-3
Sliding - 2 Rows	G180B-S-3
Overhead - 2 Rows	G180B-O-3
Fence - 2 Rows	F180B-F-3

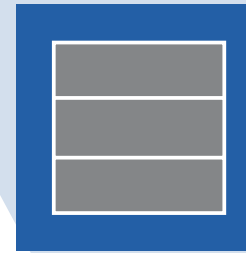

Single Swing - 3 Rows	G180B-1-1
Double Swing - 3 Rows	G180B-2-1
Sliding - 3 Rows	G180B-S-1
Overhead - 3 Rows	G180B-O-1
Fence - 3 Rows	F180B-F-1

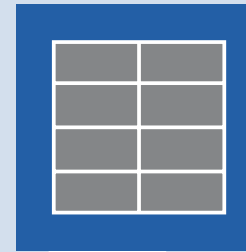

Single Swing - 4 Rows	G180B-1-2
Double Swing - 4 Rows	G180B-2-2
Sliding - 4 Rows	G180B-S-2
Overhead - 4 Rows	G180B-O-2
Fence - 4 Rows	F180B-F-2

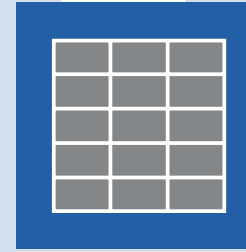

Single Swing - 5 Rows	G180B-1-5
Double Swing - 5 Rows	G180B-2-5
Sliding - 5 Rows	G180B-S-5
Overhead - 5 Rows	G180B-O-5
Fence - 5 Rows	F180B-F-5

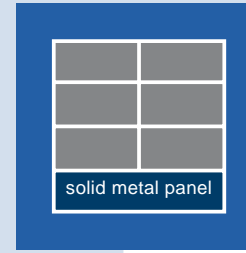

Single Swing - 4 Rows	G180B-1-4
Double Swing - 4 Rows	G180B-2-4
Sliding - 4 Rows	G180B-S-4
Overhead - 4 Rows	G180B-O-4
Fence - 4 Rows	F180B-F-4

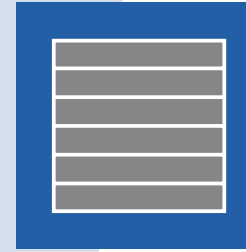

Single Swing - 6 Rows	G180B-1-6
Double Swing - 6 Rows	G180B-2-6
Sliding - 6 Rows	G180B-S-6
Overhead - 6 Rows	G180B-O-6
Fence - 6 Rows	F180B-F-6

24 Series Aluminum Gates & Fences

Our most popular design. Suitable for a wide variety of home styles. Ready for installation. Spacing available 3/8", 1/2", 3/4", 4". Available in horizontal or vertical.



24 Series Aluminum Gates & Fences

Profile	Gate Style	Product Code	Profile	Gate Style	Product Code
1 x 1 1/2 Profile: 24 x 40	Single Swing	G120-1-2	1 x 1 1/2 Profile: 24 x 40	Single Swing	G120-1-2V
	Double Swing	G120-2-2		Double Swing	G120-2-2V
	Sliding	G120-S-2		Sliding	G120-S-2V
	Overhead	G120-O-2		Overhead	G120-O-2V
	Fence	F120-F-2		Fence	F120-F-2V
1 x 2 1/2 Profile: 24 x 60	Single Swing	G120-1-3	1 x 2 1/2 Profile: 24 x 60	Single Swing	G120-1-3V
	Double Swing	G120-2-3		Double Swing	G120-2-3V
	Sliding	G120-S-3		Sliding	G120-S-3V
	Overhead	G120-O-3		Overhead	G120-O-3V
	Fence	F120-F-3		Fence	F120-F-3V
1 x 3 1/8 Profile: 24 x 80	Single Swing	G120-1-4	1 x 3 1/8 Profile: 24 x 80	Single Swing	G120-1-4V
	Double Swing	G120-2-4		Double Swing	G120-2-4V
	Sliding	G120-S-4		Sliding	G120-S-4V
	Overhead	G120-O-4		Overhead	G120-O-4V
	Fence	F120-F-4		Fence	F120-F-4V
1 x 4 Profile: 24 x 100	Single Swing	G120-1-5	1 x 4 Profile: 24 x 100	Single Swing	G120-1-5V
	Double Swing	G120-2-5		Double Swing	G120-2-5V
	Sliding	G120-S-5		Sliding	G120-S-5V
	Overhead	G120-O-5		Overhead	G120-O-5V
	Fence	F120-F-5		Fence	F120-F-5V
1 x 4 3/4 Profile: 24 x 120	Single Swing	G120-1-6	1 x 4 3/4 Profile: 24 x 120	Single Swing	G120-1-6V
	Double Swing	G120-2-6		Double Swing	G120-2-6V
	Sliding	G120-S-6		Sliding	G120-S-6V
	Overhead	G120-O-6		Overhead	G120-O-6V
	Fence	F120-F-6		Fence	F120-F-6V
1 x 6 3/8 Profile: 24 x 160	Single Swing	G120-1-7	1 x 6 3/8 Profile: 24 x 160	Single Swing	G120-1-7V
	Double Swing	G120-2-7		Double Swing	G120-2-7V
	Sliding	G120-S-7		Sliding	G120-S-7V
	Overhead	G120-O-7		Overhead	G120-O-7V
	Fence	F120-F-7		Fence	F120-F-7V
1 x 7 Profile: 24 x 180	Single Swing	G120-1-8	1 x 7 Profile: 24 x 180	Single Swing	G120-1-8V
	Double Swing	G120-2-8		Double Swing	G120-2-8V
	Sliding	G120-S-8		Sliding	G120-S-8V
	Overhead	G120-O-8		Overhead	G120-O-8V
	Fence	F120-F-8		Fence	F120-F-8V
1 x 8 1/2 Profile: 24 x 220	Single Swing	G120-1-9	1 x 8 1/2 Profile: 24 x 220	Single Swing	G120-1-9V
	Double Swing	G120-2-9		Double Swing	G120-2-9V
	Sliding	G120-S-9		Sliding	G120-S-9V
	Overhead	G120-O-9		Overhead	G120-O-9V
	Fence	F120-F-9		Fence	F120-F-9V

Mixed 24 Series Aluminum Gates & Fences

Sleek and exciting designs. Suitable for a wide variety of home styles. Ready for installation. We can mix different width profiles in the same gate or fence. These are examples. Specify design for other combinations. Available in horizontal or vertical.

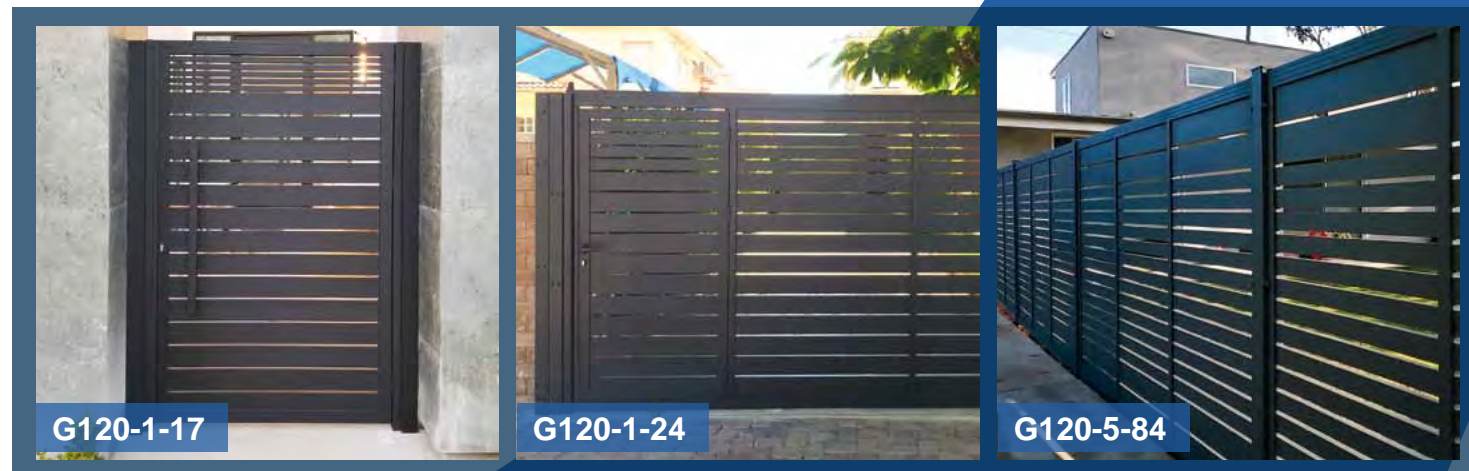

Mixed 24 Series Aluminum Gates & Fences

We can combine any of the 24 Series profiles for interesting and exciting designs.

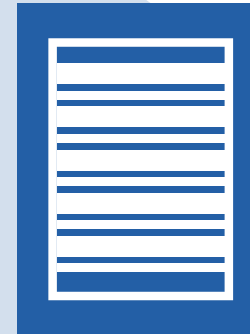

Single Swing	G120-1-25
Double Swing	G120-2-25
Sliding	G120-S-25
Overhead	G120-O-25
Fence	F120-F-25

Combination 24x100 and 24x 40

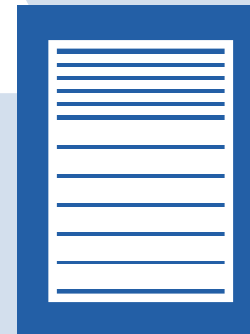

Single Swing	G120-1-17
Double Swing	G120-2-17
Sliding	G120-S-17
Overhead	G120-O-17
Fence	F120-F-17

Combination 24x24 and 24x160

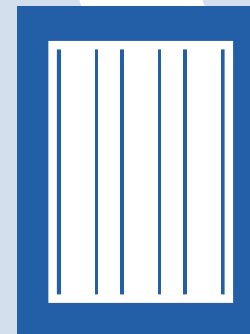

Single Swing	G120-1-79V
Double Swing	G120-2-79V
Sliding	G120-S-79V
Overhead	G120-O-79V
Fence	F120-F-79V

Combination 24x220 and 24x120

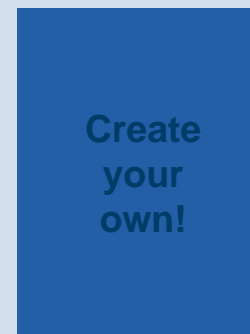

For other designs in this category use:	G120-1-0
	G120-2-0
	G120-S-0
	G120-O-0
	F120-F-0

Mixed 24 Series with Glass Aluminum Gates & Fences

Modern designs. Suitable for a wide variety of home styles. Ready for installation.
We can insert glass panels, black or white, to enhance 24 Series type gates. These are examples only.
Please specify design for any other combination. Max glass panel size 3'x4'.

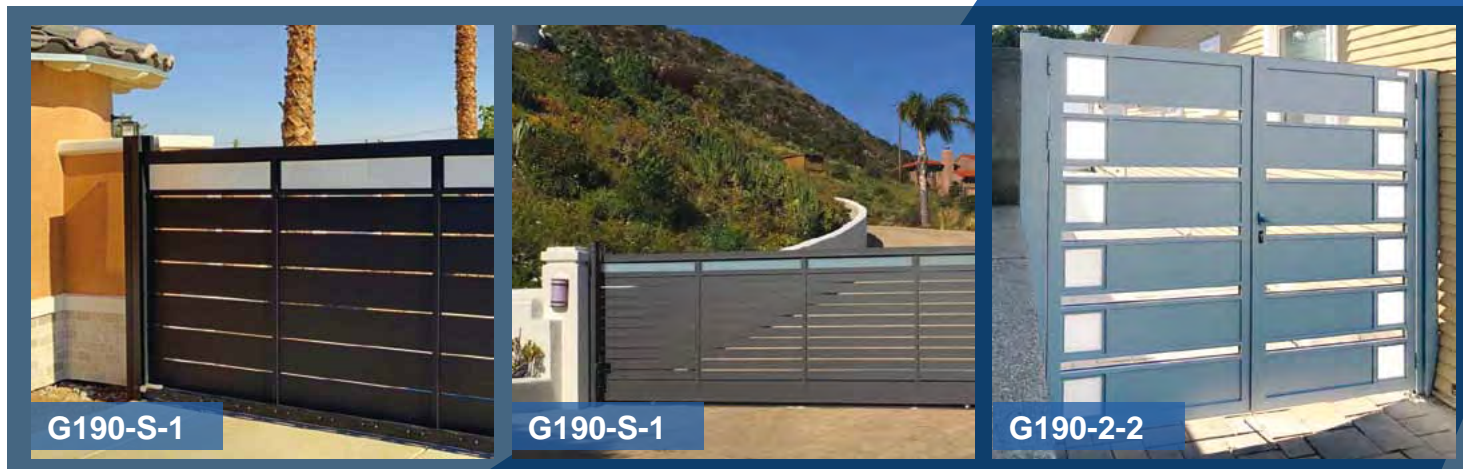
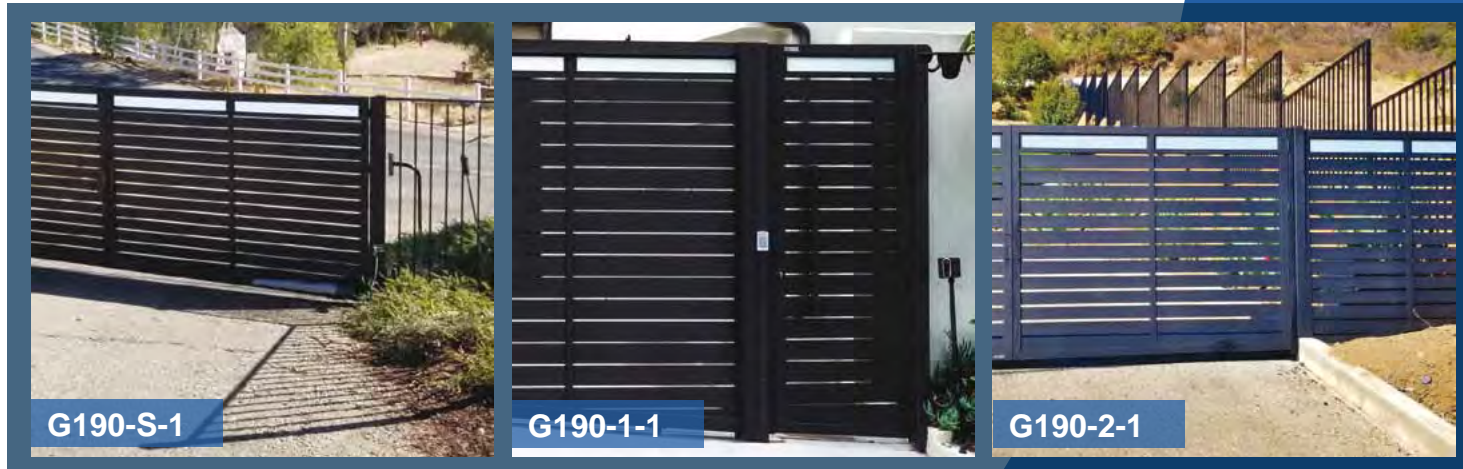

Mixed 24 Series with Glass Aluminum Gates & Fences

Use any 24 Series profile.

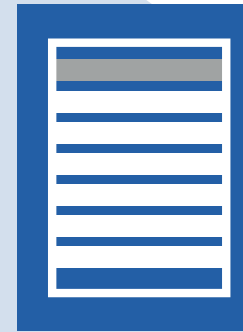

Single Swing	G190-1-1
Double Swing	G190-2-1
Sliding	G190-S-1
Overhead	G190-O-1
Fence	F190-F-1

24 x 120 with top glass insert

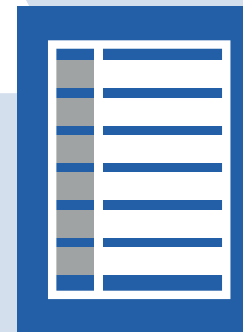

Single Swing	G190-1-2
Double Swing	G190-2-2
Sliding	G190-S-2
Overhead	G190-O-2
Fence	F190-F-2

24 x 180 with glass insert

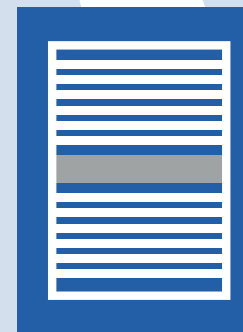

Single Swing	G190-1-3
Double Swing	G190-2-3
Sliding	G190-S-3
Overhead	G190-O-3
Fence	F190-F-3

24 x 40 with glass insert

Create your own!

For other designs in this category use:	G190-1-0
	G190-2-0
	G190-S-0
	G190-O-0
	F190-F-0

Solid Aluminum Gates & Fences

Modern designs. Suitable for a wide variety of home styles. Ready for installation.
Made with 6mm aluminum sheets.

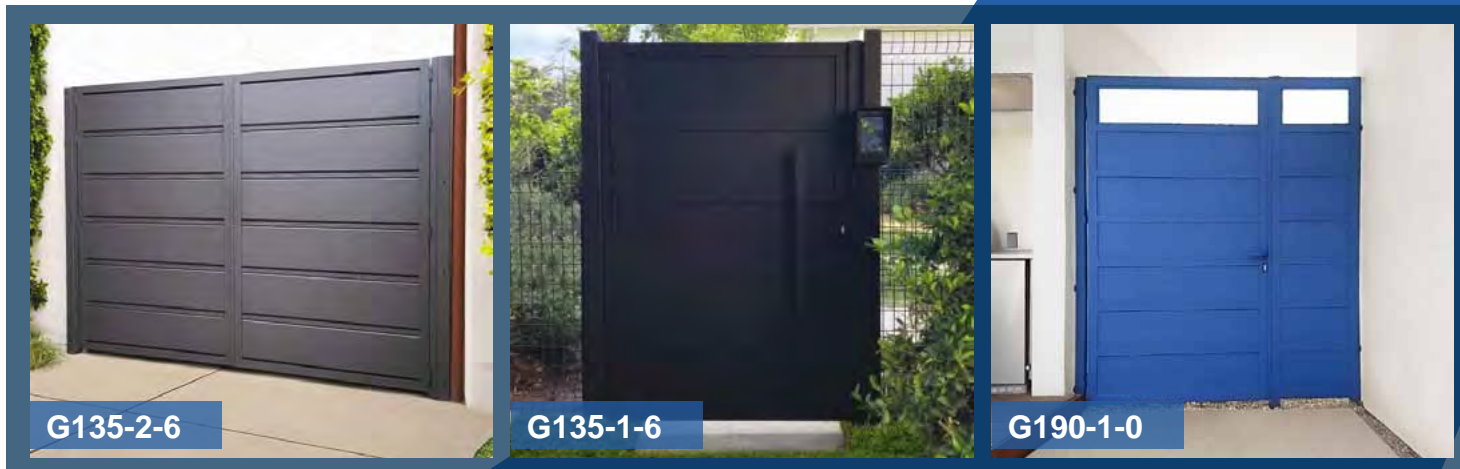
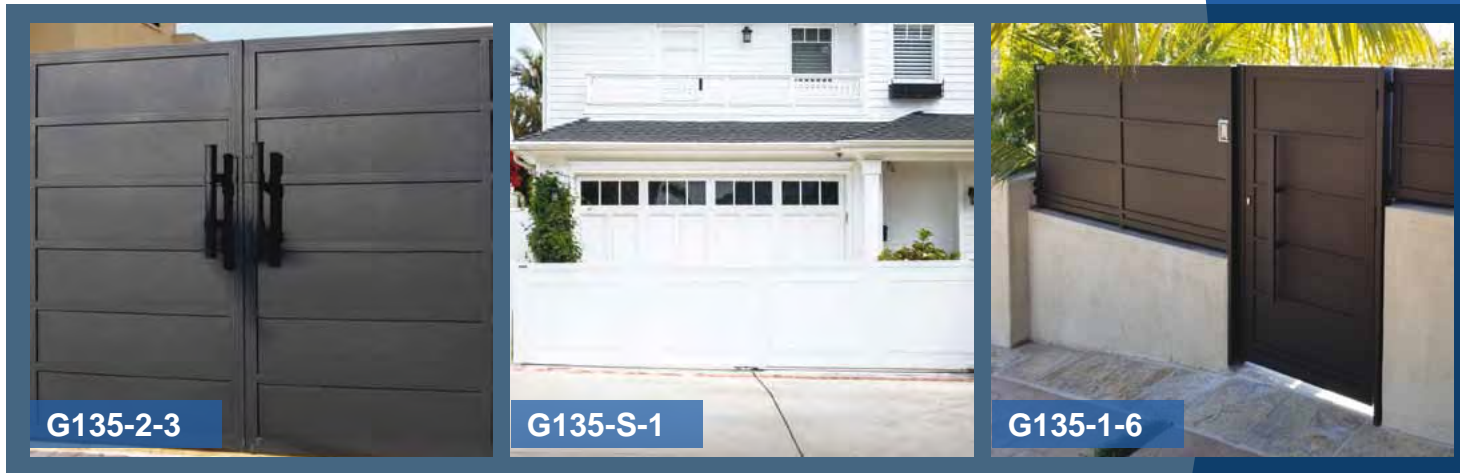

Solid Aluminum Gates & Fences

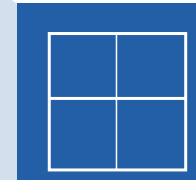

Single Swing	G135-1-3
Double Swing	G135-2-3
Sliding	G135-S-3
Overhead	G135-O-3
Fence	F135-F-3

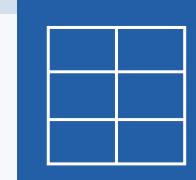

Single Swing	G135-1-1
Double Swing	G135-2-1
Sliding	G135-S-1
Overhead	G135-O-1
Fence	F135-F-1

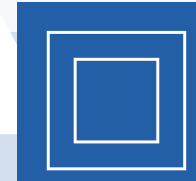

Single Swing	G135-1-11
Double Swing	G135-2-11
Sliding	G135-S-11
Overhead	G135-O-11
Fence	F135-F-11



Single Swing	G135-1-12
Double Swing	G135-2-12
Sliding	G135-S-12
Overhead	G135-O-12
Fence	F135-F-12

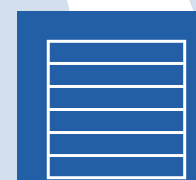

Single Swing	G135-1-6
Double Swing	G135-2-6
Sliding	G135-S-6
Overhead	G135-O-6
Fence	F135-F-6

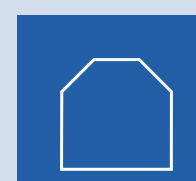

Single Swing	G135-1-13
Double Swing	G135-2-13
Sliding	G135-S-13
Overhead	G135-O-13
Fence	F135-F-13

Create your own!

For other designs in this category use: (Please specify design.)	G135-1-0
	G135-2-0
	G135-S-0
	G135-O-0
	F135-F-0

Create your own!

For other designs in this category with glass inserts use: (Please specify design.)	G190-1-0
	G190-2-0
	G190-S-0
	G190-O-0
	F190-F-0



We proudly manufacture in the U.S.

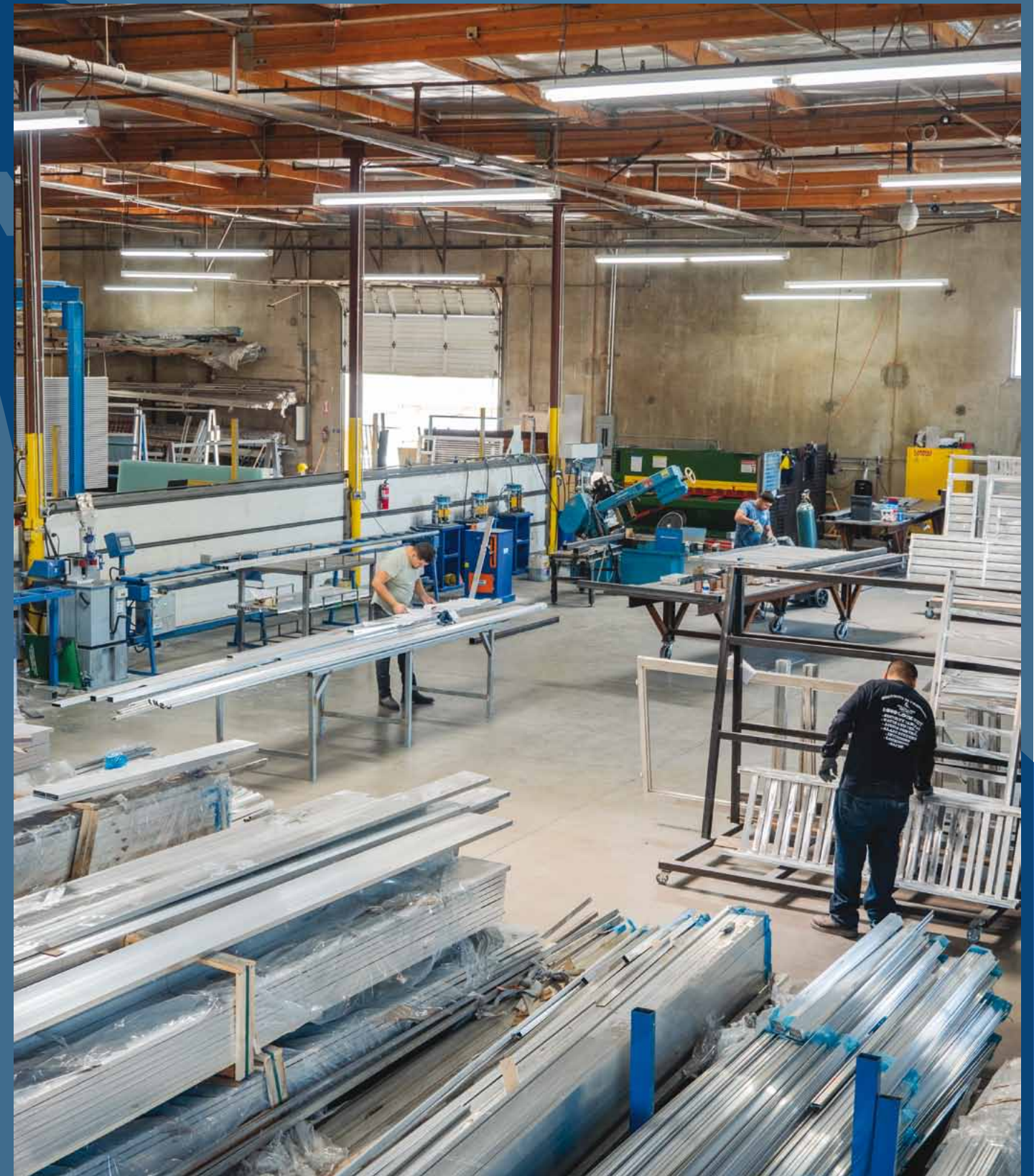

Our facility is located in Canoga Park, California.

Wood-Like Aluminum Gates & Fences

Modern designs. Suitable for a wide variety of home styles. Ready for installation. Aluminum tube wrapped in wood-like finish. Please specify wood and frame color. Frames are powder coated a solid color.



WL100-1-3



WL100-S-3



WL100-F-3



WL100-1-2



WL100-1-1



WL100-1-1



WL100-1-1

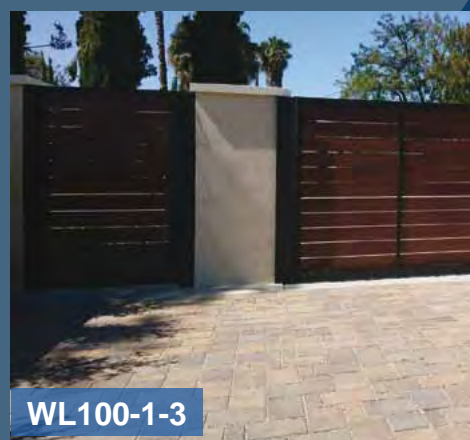

WL100-1-3



WL100-2-1

Wood-Like Aluminum Gates & Fences

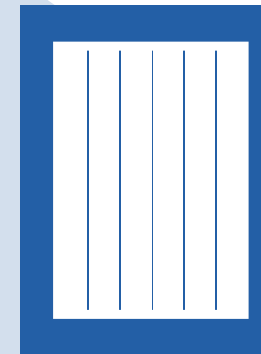

No Gaps

Single Swing	WL100-1-1
Double Swing	WL100-2-1
Sliding	WL100-S-1
Overhead	WL100-O-1
Fence	WL100-F-1

Vertical wood-like boards in painted frame. No gaps.

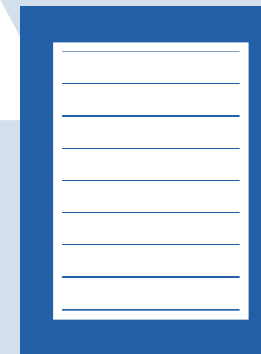

No Gaps

Single Swing	WL100-1-2
Double Swing	WL100-2-2
Sliding	WL100-S-2
Overhead	WL100-O-2
Fence	WL100-F-2

Horizontal wood-like boards in painted frame. No gaps.

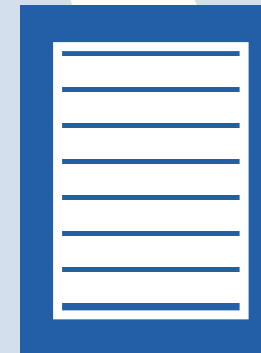

Gaps

Single Swing	WL100-1-3
Double Swing	WL100-2-3
Sliding	WL100-S-3
Overhead	WL100-O-3
Fence	WL100-F-3

Horizontal wood-like boards in painted frame with gaps.

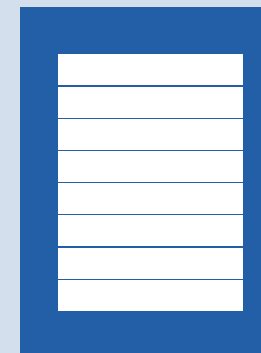

No Gaps

Single Swing	WL100-1-4
Double Swing	WL100-2-4
Sliding	WL100-S-4
Overhead	WL100-O-4
Fence	WL100-F-4

Frameless with no visible frame from the front. Currently only available for motorized gates and fences. Not for pedestrian gates.

Framed Hi-Tech Gates & Fences

Our most requested design! Suitable for a wide variety of home styles. Ready for installation. Thin 24 Series profiles in frame. This profile can be used in combinations with other 24 Series profiles.



Framed Hi-Tech Gates & Fences

Our most requested design! Suitable for a wide variety of home styles. Ready for installation. Thin 24 Series profiles in frame. This profile can be used in combinations with other 24 Series profiles.

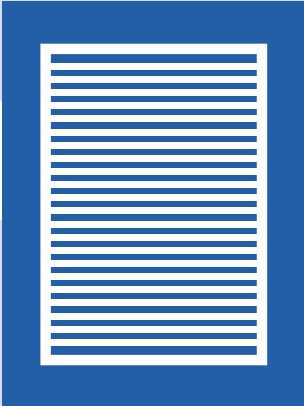

Horizontal

Single Swing	G120-1-1
Double Swing	G120-2-1
Sliding	G120-S-1
Overhead	G120-O-1
Fence	F120-F-1

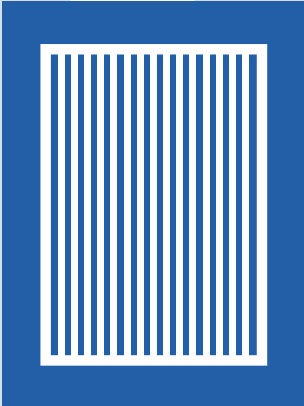

Vertical

Single Swing	G120-1-1V
Double Swing	G120-2-1V
Sliding	G120-S-1V
Overhead	G120-O-1V
Fence	F120-F-1V

Floating Hi-Tech Gates & Fences

Modern designs. Suitable for a wide variety of home styles. Ready for installation.
Profile 20 x 40. Cannot be combined with other profiles.

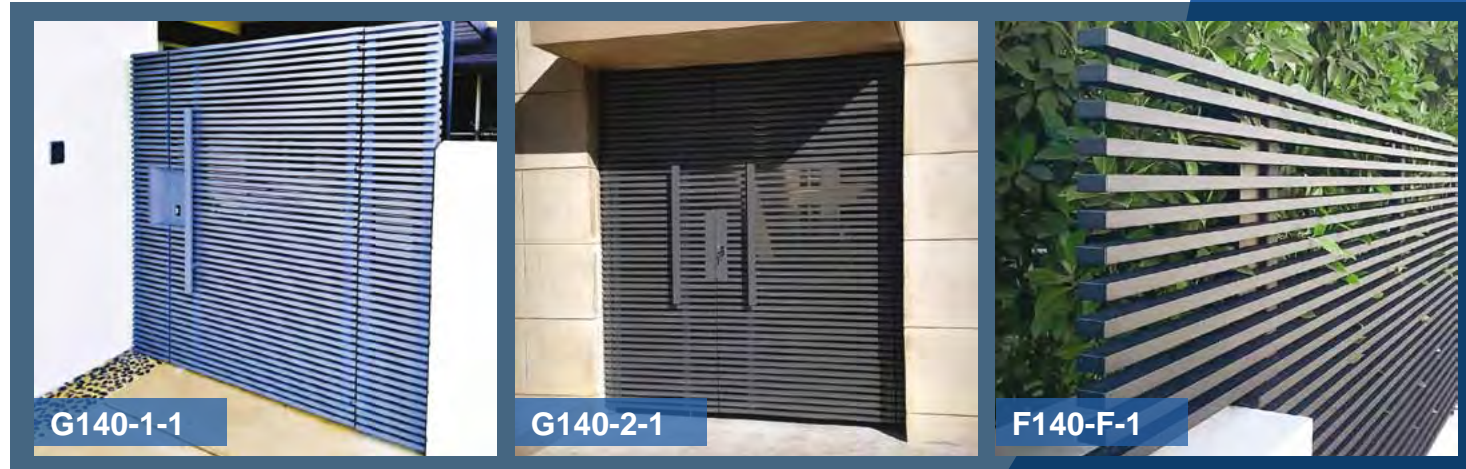
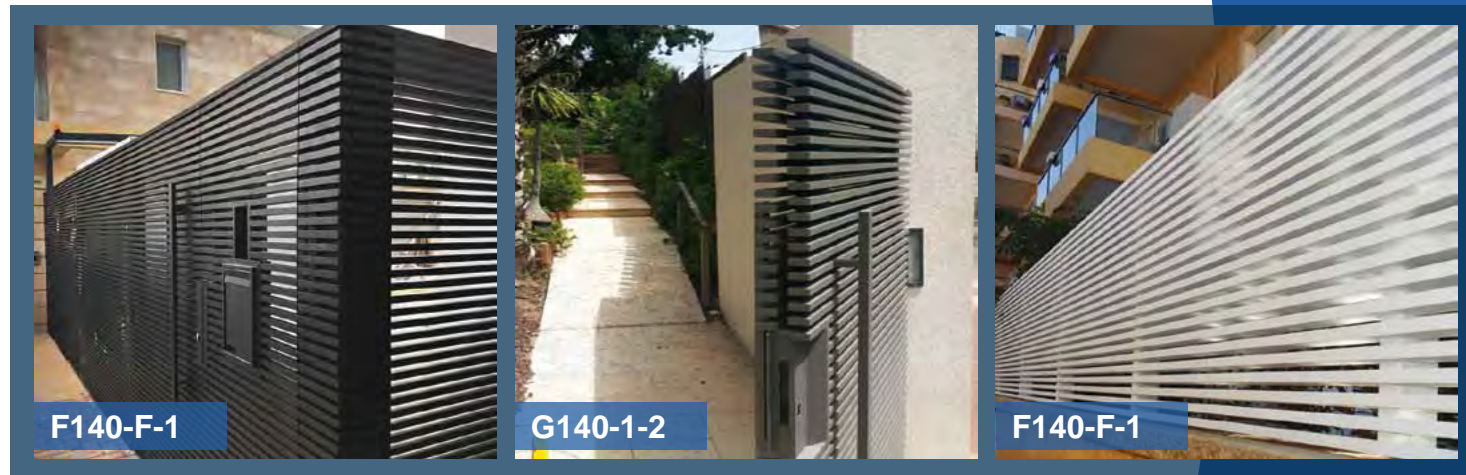

Floating Hi-Tech Gates & Fences

Modern designs. Suitable for a wide variety of home styles. Ready for installation.
Profile 20 x 40. Cannot be combined with other profiles.

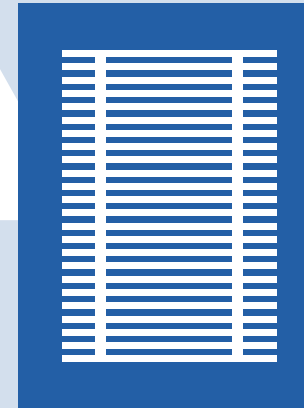

Horizontal

Single Swing	G140-1-1
Double Swing	G140-2-1
Sliding	G140-S-1
Overhead	G140-O-1
Fence	F140-F-1

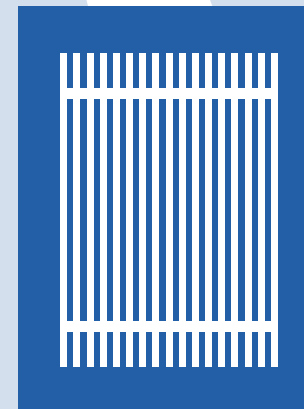

Vertical

Single Swing	G140-1-1V
Double Swing	G140-2-1V
Sliding	G140-S-1V
Overhead	G140-O-1V
Fence	F140-F-1V

Currently only available for motorized gates and for fences which do not require locks. Not for pedestrian gates.

45° Aluminum Gates & Fences

Modern designs. Suitable for a wide variety of home styles. Ready for installation. Heavy-duty profile. The profile is a bent tube at 45° to provide privacy while allowing air flow. This profile cannot be combined with other profiles.

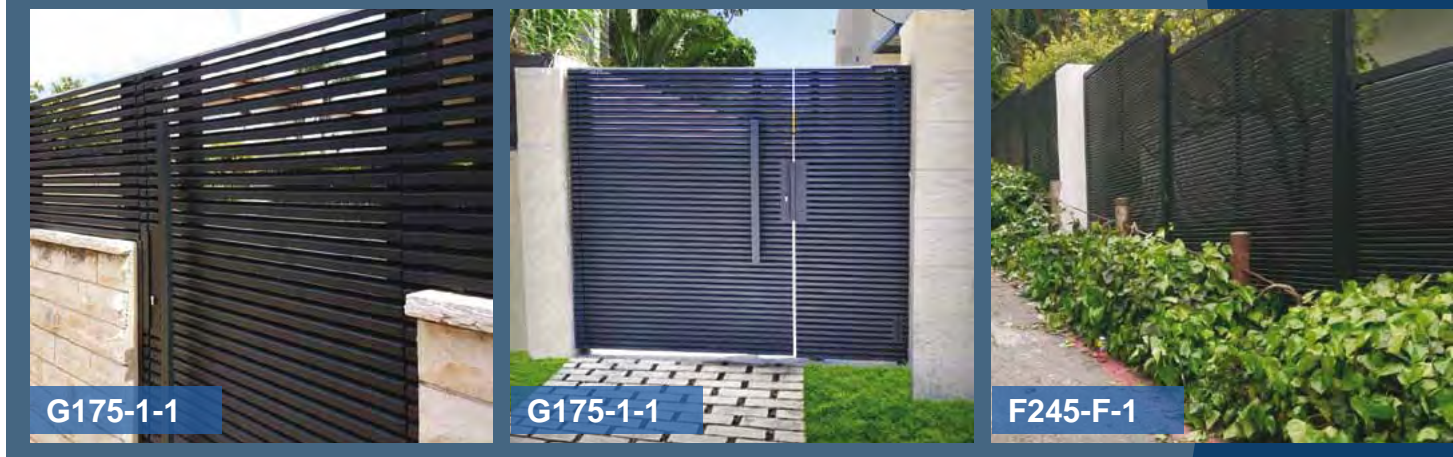

45° Aluminum Gates & Fences

Modern designs. Suitable for a wide variety of home styles. Ready for installation. Heavy-duty profile. The profile is a bent tube at 45° to provide privacy while allowing air flow. This profile cannot be combined with other profiles.

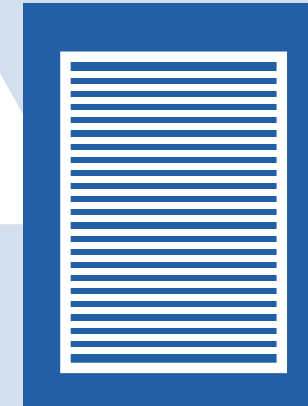

Framed

Single Swing	G245-1-1
Double Swing	G245-2-1
Sliding	G245-S-1
Overhead	G245-O-1
Fence	F245-F-1

Currently Not Available

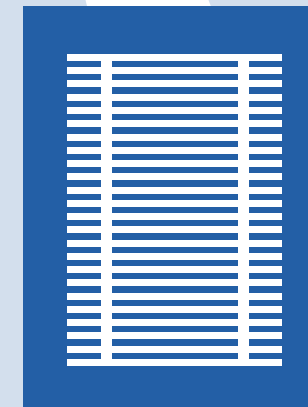

Floating

Single Swing	G175-1-1
Double Swing	G175-2-1
Sliding	G175-S-1
Overhead	G175-O-1
Fence	F175-F-1

Tandem Gates: Specialized application for areas with limited amount of space.

Tandem, stacking panels: They are perfect for areas with insufficient room to slide open.

Tandem, centralized motor: Opens gate to the right or to the left.

Allows the gate to open without blocking access.



Stacking Panels



Hidden Motor



Stacking Panels



Hidden Motor

Tandem Gates: Specialized application for areas with limited amount of space.

Tandem, stacking panels: They are perfect for areas with insufficient room to slide open.

Tandem, centralized motor: Opens gate to the right or to the left.

Allows the gate to open without blocking access.

Stacking Panels: Gate Closed (Elevation)

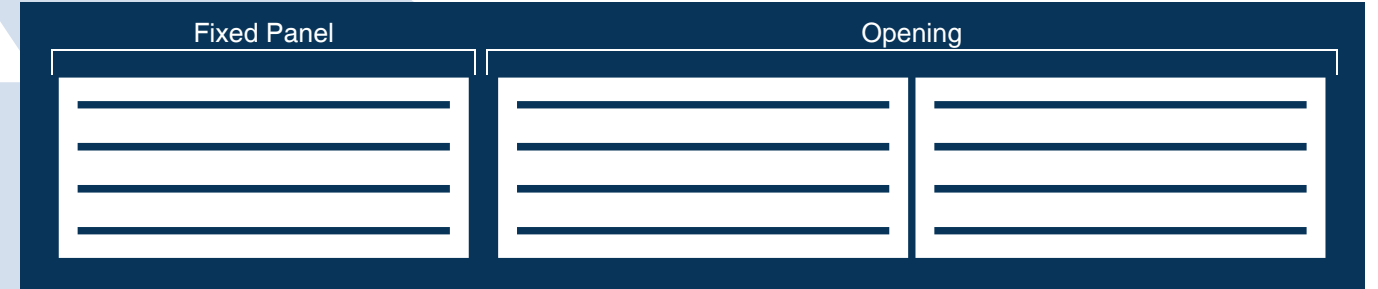

Stacking Panels: Gate Closed (Plan View)



Stacking Panels: Gate Open (Plan View)

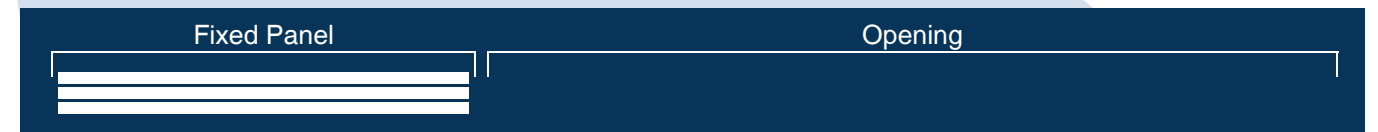

Centralized Motor: Gate Closed (Elevation)



Centralized Motor: Gate Closed (Plan View)



Centralized Motor: Gate Open (Plan View)

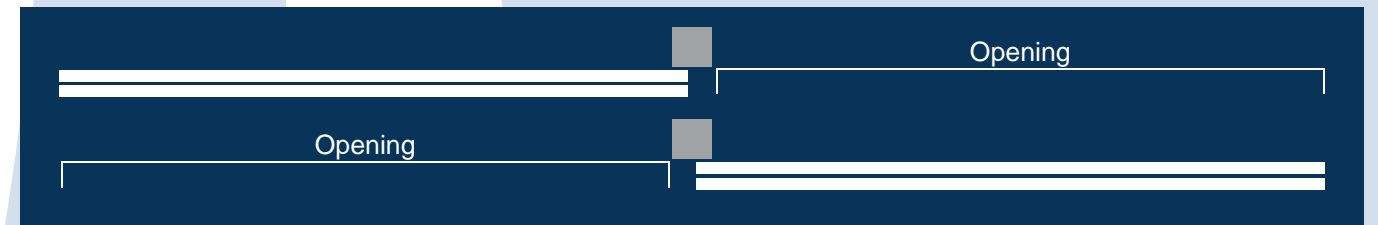

Aluminum Railing

Modern designs. Suitable for a wide variety of home styles. Ready for installation.
Heavy-duty profile. Any design we can use as a fence can be used as railing.



Aluminum Railing

Modern designs. Suitable for a wide variety of home styles. Ready for installation.
Heavy-duty profile. Any design we can use as a fence we can use as railing.

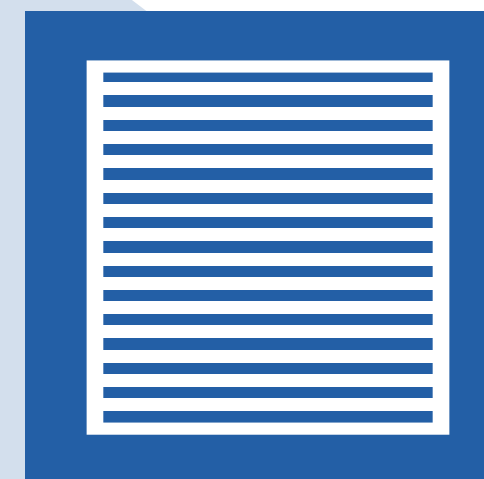

R120-S-1

Horizontal Railing

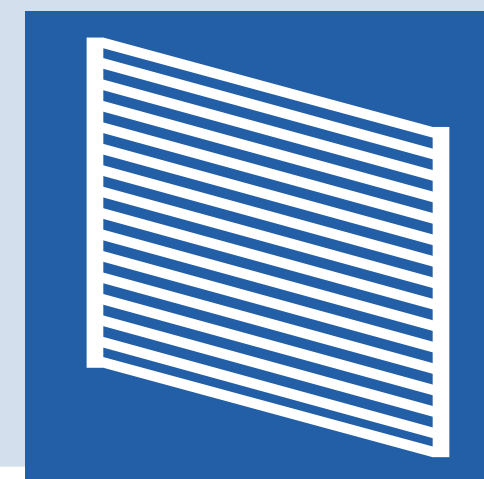

R120-T-1

Stairs Railing

Aluminum Pergolas

Modern designs. Suitable for a wide variety of home styles. Ready for installation. Heavy-duty profile. Any aluminum design we use for fences can be built as a pergola.



Aluminum Pergolas

Modern designs. Suitable for a wide variety of home styles. Ready for installation. Heavy-duty profile. Any aluminum design we use for fences can be built as a pergola.

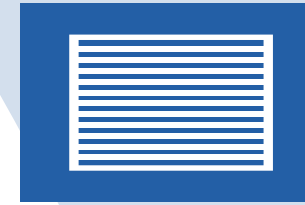

Series 24

P120-P-1	Pergola	Series 24	Post Mount
P120-P-2	Pergola	Series 24	Hang



Solid Aluminum

P135-P-1	Pergola	Solid	Post Mount
P135-P-2	Pergola	Solid	Hang

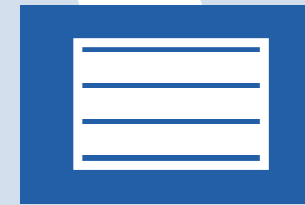

Wood-Like

P100-P-1	Pergola	Wood-Like	Post Mount
P100-P-2	Pergola	Wood-Like	Hang

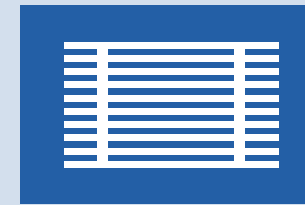

Floating Hi-Tech

P140-P-1	Pergola	Floating Hi-Tech	Post Mount
P140-P-2	Pergola	Floating Hi-Tech	Hang



A dog run for one very lucky pooch in Encino, California. March 2020



We installed a tandem gate for this homeowner who couldn't find any other solution for his wide driveway. He chose aluminum material to avoid rust on his immaculate, white gate. Pacific Palisades, California. October 2019

Crystal Line Railings

Beautiful and modern designs. Clean minimalist look
 Indoor or outdoor railings for level floor or stairs. We can install it with or without the top rail. The base shoe is made of aluminum with an anodized or powder-coated finish. No need to cover! This is a European patent, consisting of a system that allows for tilting the glass to make sure the railing is level and continuous. This system secures the glass in place. No concrete is ever needed to set the glass! Built in drainage included.

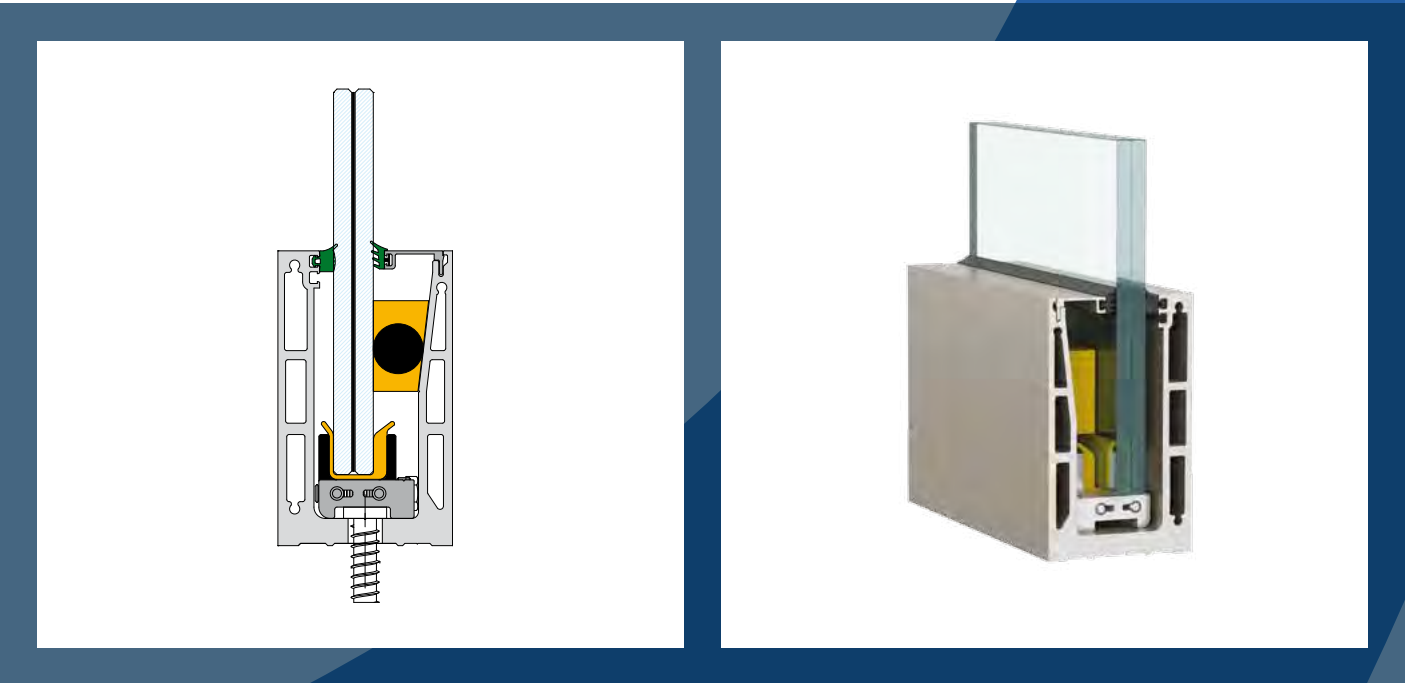

Fusion Line Railings

Beautiful and modern designs. Gives any property an elegant look.
 With or without top rail. Indoor and outdoor. Posts are powder-coated in the color of your choice.

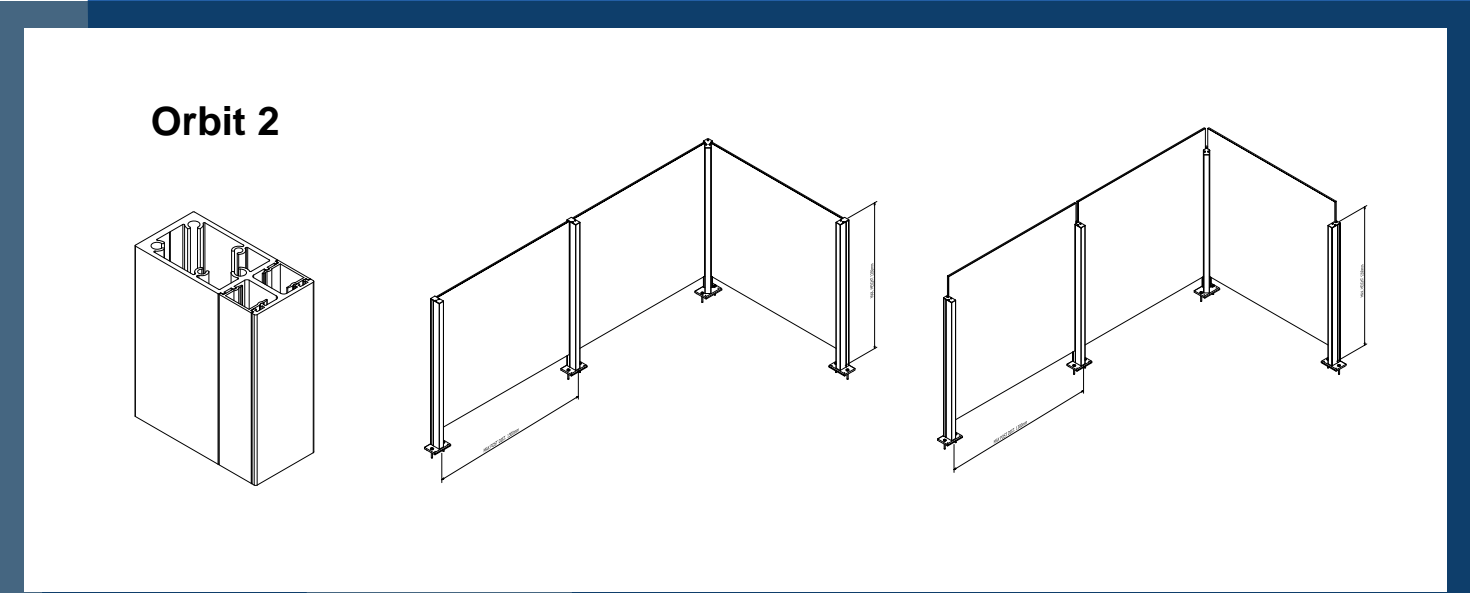
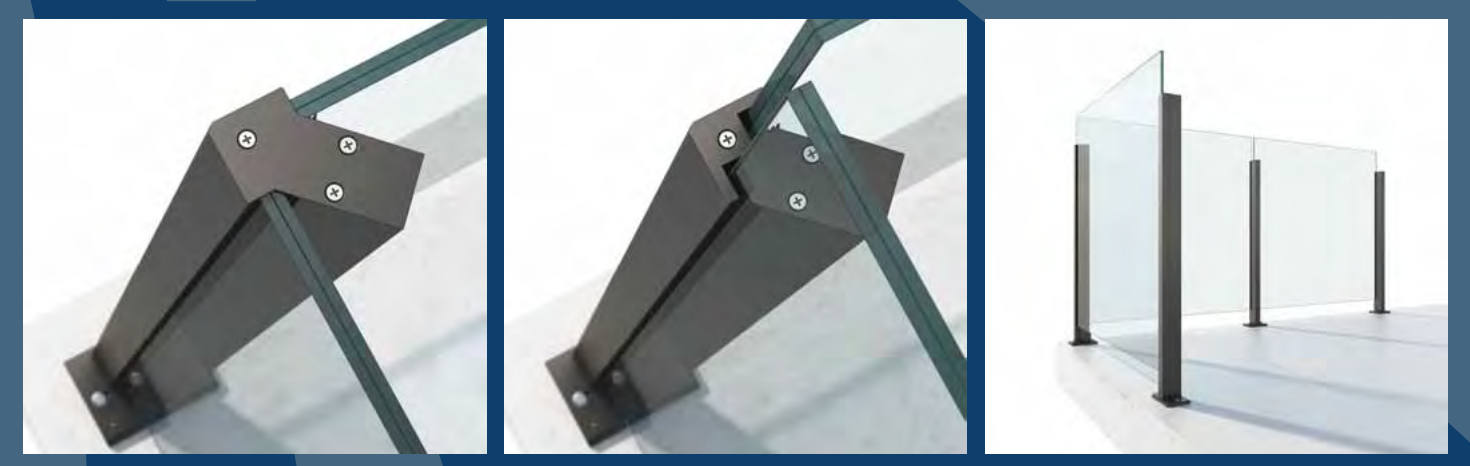

Open Air Railings

Glass railing that can expand to serve as a wind barrier. Manual operation or motorized.
The perfect solution for roof top decks, patios, outdoor dining areas and more.
Exclusive design and technology.



Open Air E Motion (Motorized)

Open air
eMOTION



MODEL	OA1800	OA2000	OA2200
Height			
Closed	3' 3"	3' 7"	3' 11"
Raised	5' 11"	6' 6"	7' 2"
Max Width Between Posts	9'	9'	9'

Open Air Plus (no bottom rail) Open Air Ultra Plus (with bottom rail)

Open air
PLUS



Open air
ULTRA+



MODEL	OA1600	OA1800	OA2000
Height			
Closed	3' 3"	3' 7"	3' 11"
Raised	5' 3"	5' 11"	6' 6"
Maximum Width Between Posts	6' 6"	6' 6"	6' 6"



Our products are unique and elegant.



Our aluminum products are perfect for all weather conditions.

Ask us about Fancy Fence

This gate and fence system is revolutionary.
Retracts into the ground when open!



**Mulholland
Brand**

21260 DEERING CT,
CANOGA PARK, CA, 91304

Phone 818.806.0711

info@mulhollandbrand.com

www.mulhollandbrand.com

